

AGILE EVO S4 2400X525

THE INNOVATIVE FULL ELECTRIC PALLET TRUCK
(1.200 KG)



AGILE EVO

The innovative motorized pallet truck that combines electric and manual function for convenient usability.

Compact, light, simple and easy to use, AGILE is the perfect pallet truck to minimize the operator effort, increasing efficiency and safety.

Ideal in deliveries, supermarket, and retail shop, it can be used by everyone.

Main advantages:

- 100% electric lift and drive, for increasing efficiency of procedures and saving time.
- Powerful battery 12.8Ah, ensuring great productivity.
- Manual switch, to be used in case of low battery to reach the charging station.

LI-ION BATTERY

Easily removable, **lightweight**, high-energy efficiency and totally **maintenance-free**, can be fully or partially recharged, ensuring great productivity.

Two types of charger available (bench and wall mounted) with standard and fast charging time.

- **3H AUTONOMY**: Continuous running with 600 kg average load at full speed.
- **RECHARGE**: Fast and occasional, depending on the combination of battery and charger.
- **CONTINUOUS RUNNING** using spare additional battery.



ADVANCED PERFORMANCES

Powerful and fast, Agile is a smart pallet truck that optimizes your productivity by being more efficient and faster.

- **DOUBLE TRACTION WHEELS WITH NON-MARKING RUBBER:** The first pallet truck with 2 traction wheels in the market, for high stability, better traction and durability.
- **1.2 TONS LOAD CAPACITY:** To cover all logistic needs.
- **AC MOTORS:** Maintenance-free motor grants reduced sound emission (Agile is among the most silent truck in the category), and is specific for intensive working cycles.
- **5.3 KM/H MAX SPEED:** Best in class in light semi-electric category.



EXCEPTIONAL EASE OF USE

The simplicity of Agile and the great maneuverability will immediately help improve your everyday work.

- **COMPACT & LIGHT:** Ideal for use in any application where space and weight is critical.
- **POWERFUL & STABLE:** Ideal for loading/unloading, slopes, uneven floors and everyday last mile deliveries.
- **SIMPLE SWITCH ON/OFF:** Equipped with the practical pocket size key switch, easily removable when the machine is not in use.



USER FRIENDLY FRONT LED INTUITIVE DISPLAY

Equipped with 3 push buttons to make easily settings and read truck activities info. Operator can get information on:

- Battery status of charge (% of charge);
- Timers (total and partial trip hour meter in h);
- Distance traveled (total and partial trip distance in km);
- Speed adjustment (% of max speed);
- Diagnostic page;
- Error page.



MULTI PURPOSES

Agile's drive unit can be combined with forks of any sizes or material like stainless steel, and also with scale system. Whatever model you choose, you will gain all the Agile advantages for the specific needs of your application.

- Special forks size
- Frame for special environments stainless steel or galvanized
- Scale options (GS/P Agile, PX Agile)
- Ultra silent version

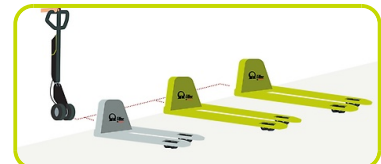

100% SAFETY

Agile is a reputable tool that cares about user safety. No worries anymore, it works hard for you giving superior results in total safety.

- **EASY SPEED ADJUSTMENT:** Safe driving performance according to operator's skill level or to workplace requirements.
- **SAFETY IN NARROW SPACE:** The turtle mode allows for controlled maneuvering in tight spaces.
- **DOUBLE WHEELS SYSTEM:** The large diameter of the wheels allows great stability and smoothness, preventing the pallet truck from overturning.

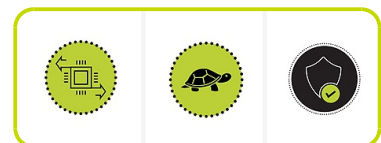

OPTIONS

- **Plus version:** extra power battery **17Ah** (including on-board charger)
- Additional spare **battery** for continuous use
- **Fast** battery charger

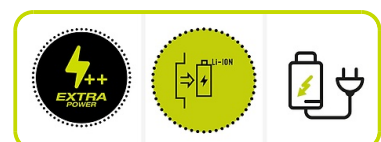

Description

1.1 Manufacturer			PR INDUSTRIAL
Lift			Electric
1.3 Drive			Electric
1.4 Operator type			Pedestrian
1.5 Load capacity	Q	kg	1200
1.6 Load centre distance	c	mm	1200
1.8 Load axle to end forks	x	mm	2182
1.9 Wheel base	y	mm	2442

Weights

2.1 Service weight (battery included)		kg	198
2.2 Axle load, laden rear		kg	794
2.2 Axle load, laden front		kg	604
2.3 Axle load, unladen front		kg	121
2.3 Axle load, unladen rear		kg	77

Tyres/Chassis

3.1 Tyres: front wheels			RUBBER
3.1 Tyres: rear wheels			POLY
3.2 Tyre size: Steering wheels - Width		mm	40
3.2 Tyre size: Steering wheels - Diameter		mm	200
3.3 Tyre size: Load rollers - Diameter		mm	82
3.3 Tyre size: Load rollers - Width		mm	60
3.5 Tyre size: rear wheels - Q.ty (X=driven)		nr	4
3.5 Tyre size: front wheels - Q.ty (X=driven)		nr	2x
3.6 Tread, front	b10	mm	162
3.7 Tread, rear	b11	mm	375

Dimensions

4.4 Lift height	h3	mm	115
4.9 Height of tiller in drive position min	h14	mm	830
4.9 Height of tiller in drive position max	h14	mm	1210
4.15 Height, lowered	h13	mm	85
4.19 Overall length	l1	mm	2880
4.20 Length to face of forks	l2	mm	480
4.21 Overall width (front/rear)	b1/ b2	mm	525
4.22 Fork dimensions - Thickness	s	mm	55
4.22 Fork dimensions - Width	e	mm	150
4.22 Fork dimensions - Length	l	mm	2400
4.25 Distance between fork arms	b5	mm	525
4.32 Ground clearance, centre of wheelbase	m2	mm	30
4.34 Aisle width	Ast	mm	3319
4.35 Turning radius	Wa	mm	2663

Performance data

5.1 Travel speed laden	km/h	4.2
5.1 Travel speed unladen	km/h	5.3
5.2 Lifting speed laden	m/s	0.018
5.2 Lifting speed unladen	m/s	0.021
5.3 Lowering speed laden	m/s	0.1
5.3 Lowering speed unladen	m/s	0.02
5.8 Max gradeability laden	%	5
5.8 Max gradeability unladen	%	10
5.10 Service brake		Electric

Electric motors

6.1 Drive motor power	kW	2x0.25
6.2 Lift motor power	kW	0.4
Battery Type	Type	Li-ion
6.4 Battery voltage	V	36
6.4 Battery capacity	Ah	12.8
6.5 Battery weight	kg	3
8.4 Sound level at driver's ear	dB(A)	60

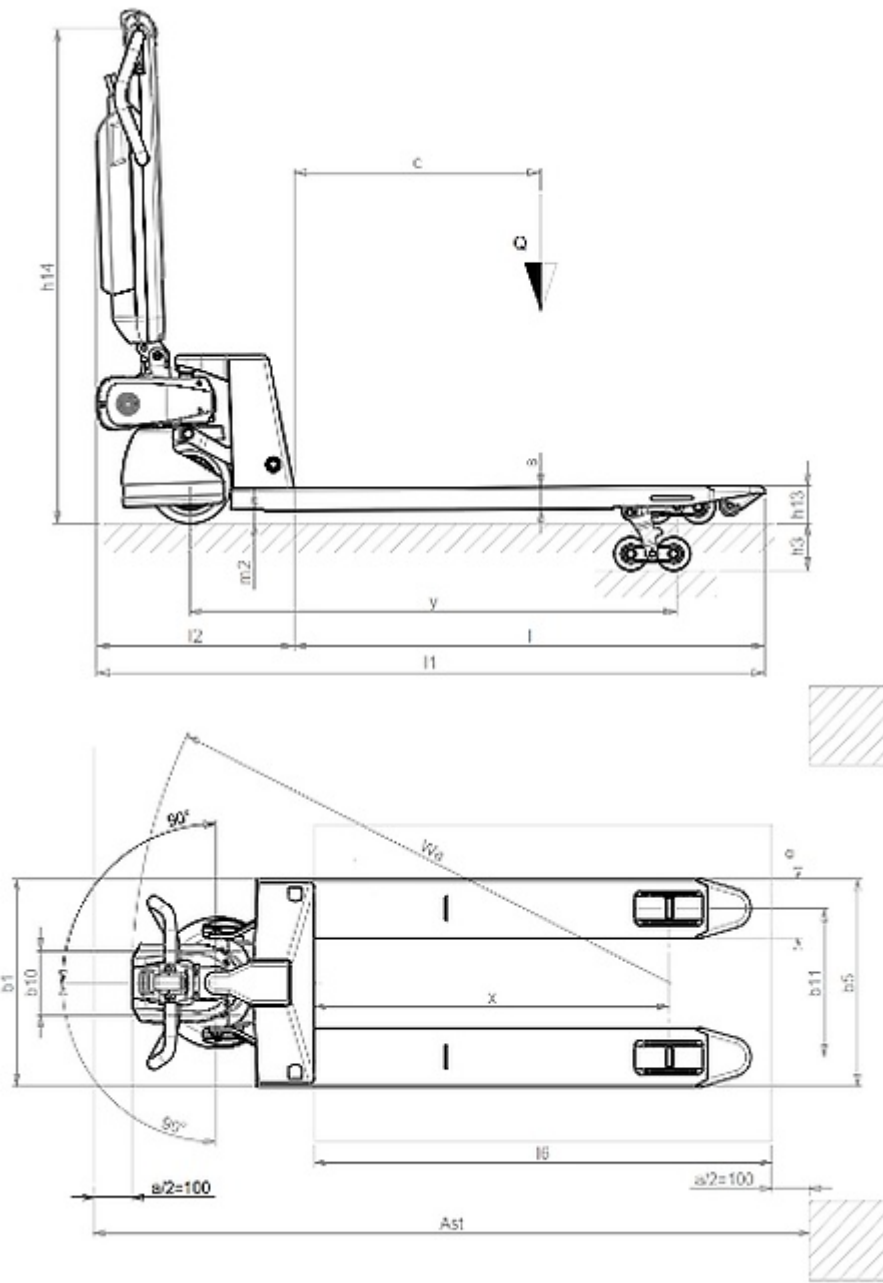

The information is aligned with the Data file at the time of download. Printed on 05/12/2023 (ID 17402)

©2023 | PR Industrial S.r.l unipersonale – Loc. Il Piano – 53031 Casole d'Elsa (SI) – ITALY. Company subject to the management and coordination of Generac Power Systems Inc. | All rights reserved | Image shown may not reflect actual package. Specifications subject to change without notice

