

GS EVO GALV 25S4 1150X525

Galvanised hand pallet truck (2.500 kg)



GS EVO GALV

The GS EVO GALV hand pallet truck is designed to handle loads in humid and damp conditions.

Suitable for environments where high hygienic standards are enforced, such as the chemical, pharmaceutical or food & beverage industry.

Very good resistance to corrosion, guaranteed thanks to the hot dip galvanizing process of the frame and the handle and geomet treatment on the rest of components.

HYDRAULIC UNIT

Resistant and reliable one piece cast iron pump with GEOMET® surface coating treatment to prevent rust pitting and corrosion damages. Designed with extreme care of details in order to have superior characteristics and features, it includes:

- **Monolithic design:** resistant and reliable one-piece housing to protect all components avoiding any accidental damages. Pump housing is processed with CNC machines to achieve high precision tolerances and high accuracy.
- **Chromed piston rod and oil seal:** in order to avoid rust and prevent oil leakage during the use.
- **Maximum pressure valve:** safety device that protects the transpallet against overloads.
- **PROPORTIONAL LOWERING VALVE:** lowering speed can be proportionally controlled according to the lever position on the tiller. Perfect working tool to carry fragile and delicate loads like crystal, glass and ceramics.



2500 kg



200 mm



TILLER

3D Superior Ergonomic shape tiller, with enhanced ergonomics. Compared to a conventional tiller, this shape allows the operator to have a good position when pushing the loads with maximum efficiency without fatigue. This thanks to two large grasping side areas specifically designed to have a correct position during operation of the truck.



EASY TO MOUNT

Tiller easy to assemble with a fast mounting system. Robust tiller connection with two full welded joints that assure superior sturdiness in the toughest application.

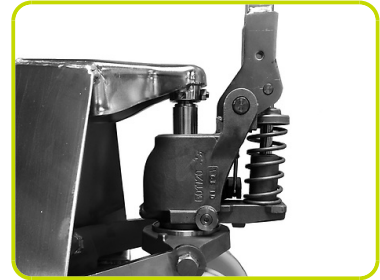

Description

1.1 Manufacturer			LIFTER
1.3 Drive			Manual
1.4 Operator type			Pedestrian
1.5 Load capacity	Q	Kg	2500
1.6 Load centre distance	c	mm	600
1.8 Load axle to end forks	x	mm	932
1.9 Wheel base	y	mm	1192

Weights

2.1 Service weight		Kg	63
2.2 Axle load, laden rear		Kg	1825
2.2 Axle load, laden front		Kg	738
2.3 Axle load, unladen rear		Kg	21
2.3 Axle load, unladen front		Kg	42

Tyres/Chassis

3.1 Tyres: front wheels			NYLON
3.1 Tyres: rear wheels			NYLON
3.2 Tyre size: Steering wheels - Diameter		mm	200
3.2 Tyre size: Steering wheels - Width		mm	50
3.3 Tyre size: Load rollers - Diameter		mm	82
3.3 Tyre size: Load rollers - Width		mm	60
3.5 Tyre size: rear wheels - Q.ty (X=driven)		nr	4
3.5 Rear balancing axle			No
3.6 Tread, front	b10	mm	155
3.7 Tread, rear	b11	mm	375

Dimensions

4.4 Lift height	h3	mm	115
4.9 Height of tiller in drive position max	h14	mm	1185
4.9 Height of tiller in drive position min	h14	mm	710
4.15 Height, lowered	h13	mm	85
4.19 Overall length	l1	mm	1550
4.20 Length to face of forks	l2	mm	400
4.21 Overall width	b1	mm	525
4.22 Fork dimensions - Thickness	s	mm	55
4.22 Fork dimensions - Width	e	mm	150
4.22 Fork dimensions - Length	l	mm	1150
4.25 Distance between fork arms	b5	mm	525
4.32 Ground clearance, centre of wheelbase	m2	mm	30
4.34 Aisle width	Ast	mm	2048
4.35 Turning radius	Wa	mm	1367

Performance data

5.2 Lifting speed laden	strokes	12
5.2 Lifting speed unladen	strokes	12

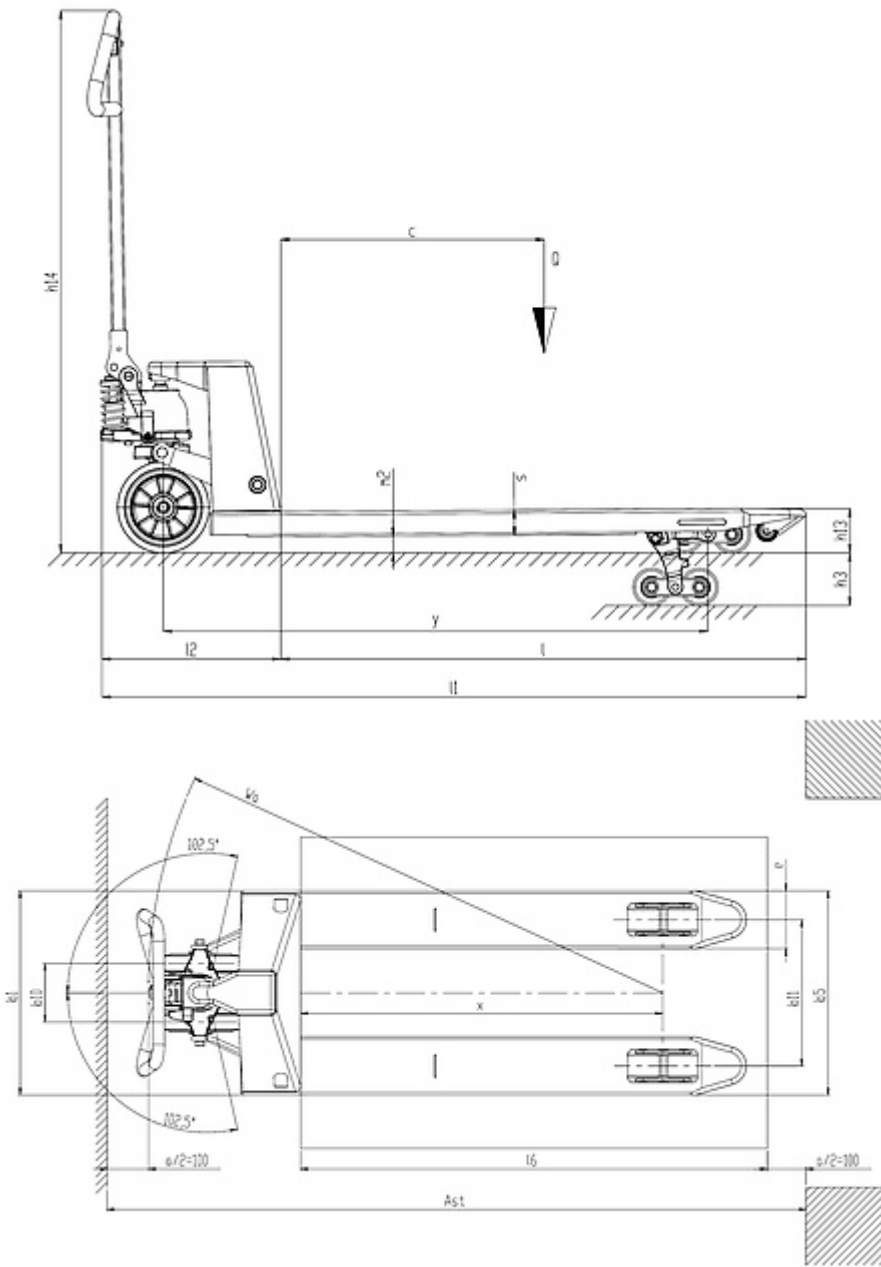

The information is aligned with the Data file at the time of download. Printed on 28/12/2020 (ID 12774)

©2020 | PR INDUSTRIAL s.r.l. | All rights reserved | Image shown may not reflect actual package. Specifications subject to change without notice

